

XR4 433 C - XR4 868 C

1 DESCRIPTION

The XR C control board is a four-channel external receiver, which has an integrated decoding system (DS, SLH, LC), named OMNIDEC. When a channel is activated by radio control (DS, SLH, LC), the relevant N.O relay contact closes by the methods described in chapter 5.

The selectable configurations are :

CH1= pulsed N.O. relay output

CH2= pulsed/fixed N.O relay output (selectable by DS1)

CH3= pulsed N.O. relay output

CH4= timed N.O. relay output (can be adjusted with SW5)

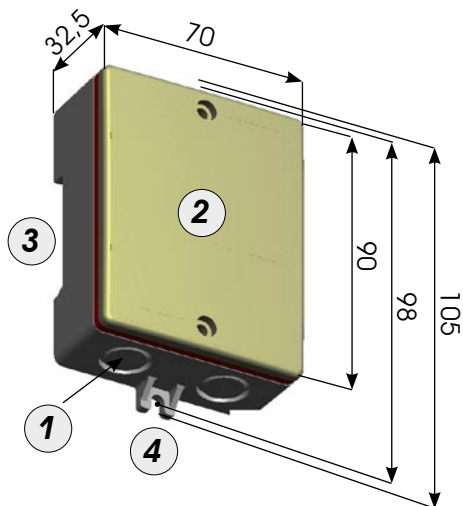

SLOW FLASHING DL6	30 SECS. TIME BASE SELECTED AND OUTPUT ACTIVE	
FAST FLASHING DL6	1 SEC. TIME BASE SELECTED AND OUTPUT ACTIVE	
DS1	ON	OFF
DIP-SWITCH 1	CHANNEL 2 FIXED OUTPUT	CHANNEL 2 PULSED OUTPUT
DIP - SWITCH 2	CHANNEL 4 TIME BASE 1 SECOND SELECTION (SEE CHAP. 6)	CHANNEL 4 TIME BASE 30 SECONDS SELECTION (SEE CHAP.6)

- ① Preperforated facility for cable grippers (16.5 diam)
- ② Cover
- ③ Facility for securing on DIN guide
- ④ Fittings for screw securing
- ⑤ Terminals for command output (N.O.)
- ⑥ Normally open (N.O.) relay contact
- ⑦ Signalling LEDs (ON= OUTPUT ACTIVE)
DL1=LED CH 1 DL2=LED CH2
DL3=LED CH3 DL4=LED CH4
- ⑧ Radio programming push-buttons
SW1=PUSH-BUTTON CH1 SW2=PUSH-BUTTON CH2
SW3=PUSH-BUTTON CH3 SW4=PUSH-BUTTON CH4
- ⑨ DL6: LED signalling time programming CH4
- ⑩ SW5: Time programming push-button CH4
- ⑪ Selection dip-switch
- ⑫ Power supply terminal
- ⑬ Terminal for antenna
- ⑭ DL5: Mains ON LED (ON=MAINS PRESENT)

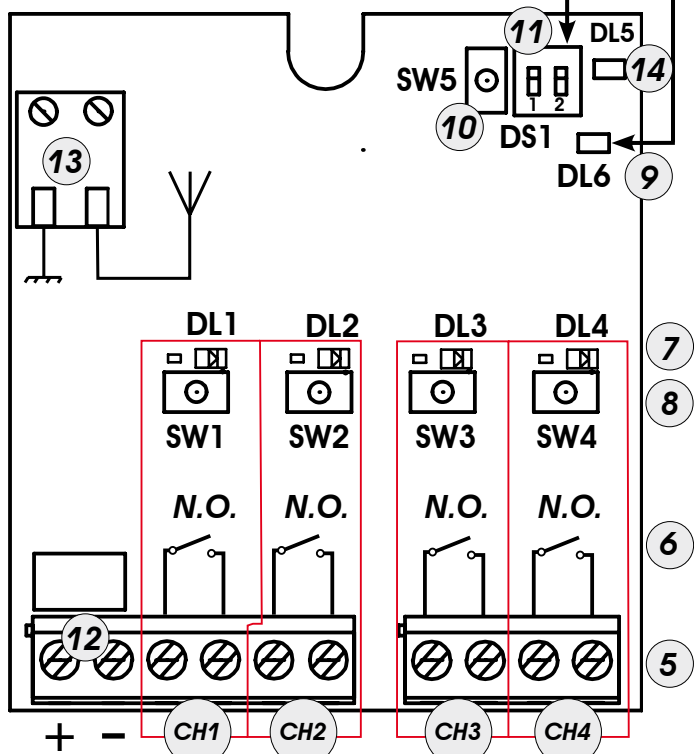



Fig.1

2 TECHNICAL SPECIFICATIONS

	XR4 433 C	XR 868 C
POWER SUPPLY (V)	12 ÷ 24 ac-dc	12 ÷ 24 ac-dc
RECEPTION FREQUENCY (MHz)	433.92 ±0.1	868.35±0.2
ABSORBED CURRENT (mA)	100 mA	100 mA
DECODING (OMNIDEC SYSTEM)	DS-LC-SLH	DS-SLH
SAVEABLE CODES	250 CH1-2 / 250 CH 3-4	250 CH1-2 / 250 CH 3-4
NUMBER OF CHANNELS	4	4
NUMBER OF RELAY OUTPUTS (N.O.)	N 2 pulsed (CH 1-3) N 1 pulsed/fixed (selectable) (CH2) N 1 timed (CH4)	N 2 pulsed (CH 1-3) N 1 pulsed/fixed (selectable) (CH2) N 1 timed (CH4)
RELAY CONTACTS CAPACITY	0.5 A / 120 VA	0.5 A / 120 VA
PROTECTION CLASS	IP 44	IP 44
OPERATING AMBIENT TEMPERATURE (°C)	-20 / +55	-20 / +55

ENGLISH

3 MEMORY STORAGE OF RADIO CONTROLS

 At the most two types of radio coding (DS, SLH, LC) can simultaneously coexist on the XR C board; the first coding (e.g. SLH) on channels 1 and 2, the second (e.g. DS) on channels 3 and 4.

 To change over from one code to another, you must delete the existing one (see paragraph on deletion), and repeat the memory-storage procedure.

 A maximum of 250 codes for channels 1-2 and 250 codes for channels 3-4 can be memory stored.

3.1 MEMORY STORAGE OF DS REMOTE CONTROLS

- 1) On the DS radio control, select the required ON-OFF combination for the 12 dip switches.
- 2) Press for 1 second, the push-button on the receiver (Fig. 1 ref. ⑧) relating to the channel you wish to associate with the radio control
- 3) The relevant LED on the receiver (Fig. 1 ref. ⑦) begins to flash slowly for 5 secs.
- 4) Within these 5 secs., press the appropriate push-button on the radio control.
- 5) The relevant LED (Fig. 1 ref. ⑦) lights up on steady beam for 1 second and then goes OFF, indicating that storage was executed.

 **The board will send a command to the output associated with the channel.**

- 6) To add other radio controls, set the same ON - OFF combination used in point 1).

3.2 MEMORY STORAGE OF SLH REMOTE CONTROLS

- 1) On the SLH **master** radio control, simultaneously press and hold down push-buttons P1 and P2.
- 2) The radio control LED begins to flash (for about 10 secs.).
- 3) Release both push-buttons.
- 4) Press, for 1 second, the push-button on the receiver (Fig. 1 ref. ⑧) relating to the channel you wish to associate with the radio control.
- 5) The relevant LED on the receiver (Fig. 1 ref. ⑦) begins to flash slowly for 5 secs.
- 6) Within these 5 secs., while the radio control LED is still flashing, press and hold down the required push-button on the radio control (the radio control LED lights up on steady beam).
- 7) The LED on the board (Fig. 1 ref. ⑦) lights up on steady beam for 1 second and then goes OFF, indicating that storage was executed.
- 8) Release the radio control push-button.
- 9) Quickly press twice in succession the memory stored radio control push-button.

 **The board will send a command to the output associated with the channel.**

- 10) To add other radio controls, transfer the code of the memory-stored push-button of the radio control to the relevant push-button of the radio controls to be added, observing the following procedure:

a) On the memory stored radio control, simultaneously press and hold down push-buttons P1 and P2.

- b) The radio control LED begins to flash.
 - c) Release both push-buttons.
 - d) Press the memory stored push-button and hold it down (the radio control LED lights up on steady beam).
 - e) Bring the radio controls near, press and hold down the push-button of the radio control to be added, releasing it only after the double flash of the radio control LED, which indicates learning was executed.
- Quickly press twice the push-button of the new memory stored radio control.

 **The board will send a command to the output associated with the channel.**

3.3 MEMORY STORAGE OF LC REMOTE CONTROLS

 **The LC radio coding is available only for certain markets and only for receiver XR433C.**

- 1) Press, for 1 second, the push-button on the receiver (Fig. 1 ref. ⑧) relating to the channel you wish to associate with the radio control.
- 2) The relevant LED on the receiver (Fig. 1 ref. ⑦) begins to flash slowly for 5 secs.
- 3) Within these 5 secs., press the appropriate push-button on the LC remote control.
- 4) The LED on the receiver (Fig. 1 ref. ⑦) lights up on steady beam for 1 second, indicating memory storage was executed, and then resumes flashing for another 5 secs., during which another radio control can be memory stored.
- 5) When the 5 secs. have elapsed, the LED goes OFF indicating the end of the procedure.
- 6) To memory store other radio controls, repeat the previous procedure.

If you wish to proceed in remote mode, (without opening the receiver container), follow the procedure below:

- a) Take an already memory stored radio control.
- b) Press and simultaneously hold down push-buttons P1 and P2 until the flashing light of the LED (Fig. 1 ref. ⑦) on the receiver board lights up.
- c) The LED will flash slowly for 5 secs.
- d) Within 5 secs. press the push-button of the radio control that had been memory stored to enable learning on the selected channel.
- e) The LED on the board relating to the channel being learned flashes for 5 secs., within which time the code of another radio control must be transmitted.
- f) The LED (Fig. 1 ref. ⑦) lights up on steady beam for 2 seconds, indicating memory storage was executed, and then resumes flashing for 5 secs., during which point "e" can be repeated, and also the subsequent points, for other remote controls and finally goes OFF.

4 DELETION OF ALL RADIO CONTROLS ASSOCIATED WITH CHANNELS 1-2 OR 3-4

 **This operation is NOT reversible and, if the radio controls associated with channels 3-4 are deleted, it also entails the deletion of activation timer of output 4.**

- 1) To delete **ALL** the radio control codes associated with **channels 1-2 or 3-4**, hold down the relevant push-button (Fig. 1 ref. ⑧) for 10 seconds.
(e.g. TO DELETE ALL RADIO CONTROLS ASSOCIATED WITH CHANNELS 1-2, PRESS SW1 OR SW2).

- 2) The LED (Fig.1 ref. ⑦) relating to the pressed push-button flashes for the first 5 secs., and then flashes more quickly for the next 5 secs.
- 3) The LED lights up on steady beam for 2 secs. and then goes OFF.
- 4) Release the pressed push-button when the relevant LED lights up on a steady beam.

5 FUNCTION LOGIC

 You can command the receiver channels from different radio controls. (E.g.: radio control 1 commands channel 1, radio control 2 commands channel 2, etc..)

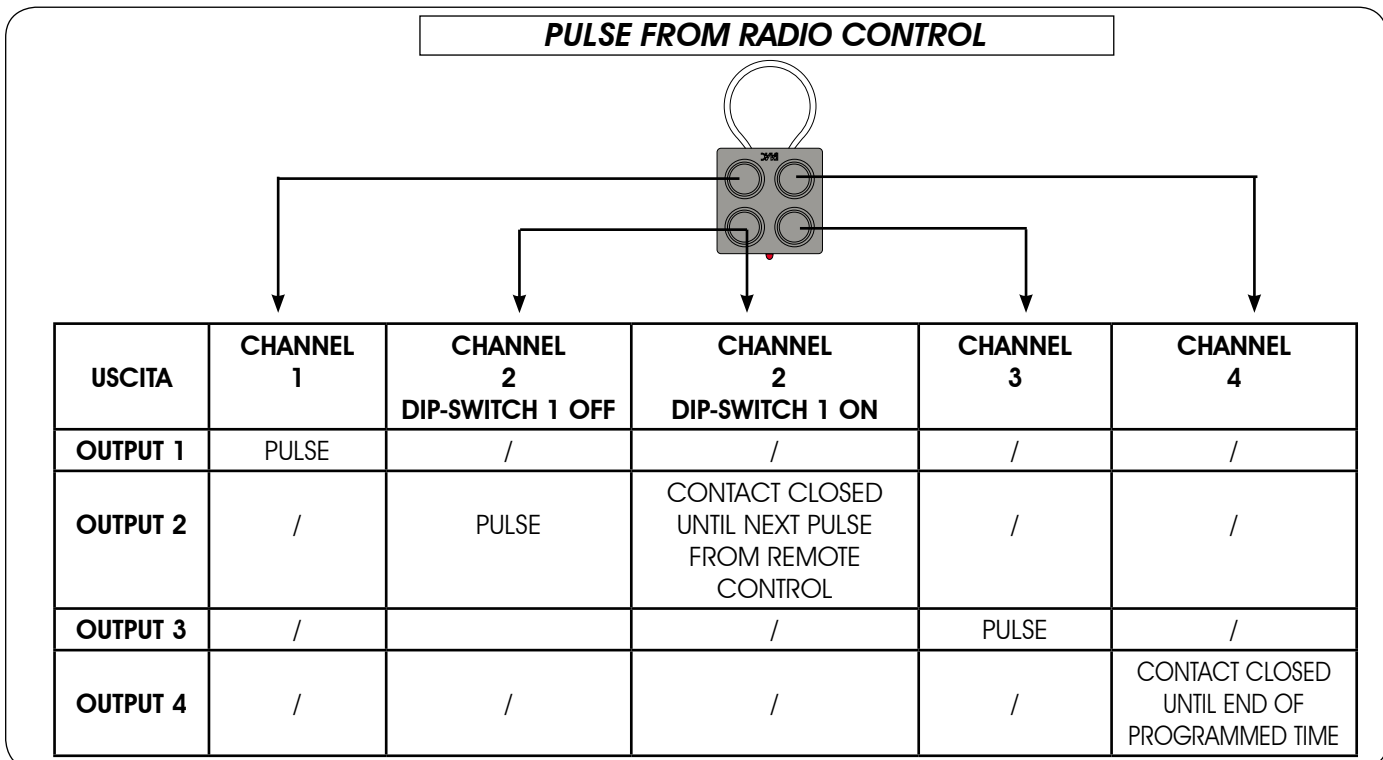

6 OUTPUT 4 ACTIVE TIME PROGRAMMING

If you give a pulse to channel 4 from the radio control, output 4 (closed contact) is activated for a programmable time varying from **a minimum of 1 sec to a maximum of 127.5 minutes**.

To programme time, first of all **select, with dip switch 2, the time base** with which the board will count (see table fig.1); next press the SW5 key (Fig.1 ref.⑩) until you reach the selected time (LED DL6 briefly lights up whenever the relevant key is pressed). Wait for 5 secs. **without pressing any key**, until LED DL6 lights up on steady beam for 3 seconds. (To exit programming)

EXAMPLE 1:

OUTPUT ACTIVATION TIME 4=5 minutes

- 1) Select 30 secs. time base
(Dip-switch 2 OFF)
- 2) Press key SW5 (Fig.1 ref. ⑩) 10 times.
(time base 30 secs. X 10 pressings = 5 min.)
- 3) Do not press any key for 5 secs. until you exit programming.

EXAMPLE 2:

OUTPUT ACTIVATION TIME 4=20 seconds

- 1) Select 1 sec. time base.
(Dip-switch 2 ON)
- 2) Press key SW5 (Fig.1 ref. ⑩) 20 times.
(time base 1 sec. X 20 pressings = 20 sec.)
- 3) Do not press any key for 5 secs. until you exit programming.

 IF OUTPUT 4 IS ACTIVE, LED DL4 IS LIGHTED, WHEREAS LED DL6 FLASHES ACCORDING TO THE SELECTED TIME BASE

SLOW FLASHING DL6	30 SECS. TIME BASE SELECTED AND OUTPUT ACTIVE
FAST FLASHING DL6	1 SEC. TIME BASE SELECTED AND OUTPUT ACTIVE

 TO MODIFY OR CHANGE ACTIVATION TIME OF OUTPUT 4, REPEAT THE PROGRAMMING OPERATION.